

DAC TESTING USING MODULATED SIGNALS

Pavel Fexa, Josef Vedral, Jakub Svatoš

CTU Prague, Faculty of Electrical Engineering Department of Measurement, Technická 2, 16627, Prague 6, Czech Republic
(✉ fexap1@fel.cvut.cz, +420 22 435 2201, ✉ vedral@fel.cvut.cz, +420 22 435 2182, ✉ svatoja1@fel.cvut.cz, +420 22 435 2201)

Abstract

This document analyses qualities of methods used for testing dynamical parameters of Digital-to-Analog Converters (DAC) using a multi-frequency signal. As the source for these signals, Amplitude Modulated (AM) and Frequency Modulated (FM) signals are used. These signals are often used in radio engineering. Results of the tests, like *Effective Number of Bits (ENOB)*, *Signal-to-Noise and Distortion (SINAD)*, are evaluated in the frequency domain and they are compared with standard results of Sine Wave FFT test methods. The aim of this research is firstly to test whether it is possible to test a DAC using modulated signals, secondly to reduce testing time, while estimating band performance of DAC.

Keywords: Digital-to-analog converter, ENOB, Signal-to-noise and distortion - SINAD, FFT analysis, Crest Factor (CF).

© 2011 Polish Academy of Sciences. All rights reserved

1. Introduction

This work comes out from standards for Analog-to-Digital Converters (ADC) testing and uses this method for DAC testing. Almost all dynamic methods can be applied to ADC as well as to DAC. In the field of dynamic ADC testing there are several well-described methods used. Standardized methods like *Sine Wave Fit Test* or *FFT (resp. DFT) Test* are using high spectrum purity input signals. The *ENOB*, *SINAD*, *Total Harmonic Distortion (THD)*, *Signal Non-harmonic Distortion SNHR*, *Spurious Free Dynamic Range SFDR*, and *Intermodulation Distortion IMD* can be determined with high accuracy by these methods [1, 2, 3]. However, these tests are relatively time-consuming, especially when it is necessary to analyze the frequency characteristic of these parameters. A possible way to shorten the test duration is to drive the input of an ADC by a multi-tone signal, or generate a multi-tone signal with a DAC.

For example, the exponential signal can be considered as a typical example of a multi-frequency signal, and it is to be generated with a passive RC circuit driven by a rectangular generator. Unfortunately, the spectrum amplitude frequency characteristic of the exponential signal falls with a slope of -20 dB per decade [4, 5, 6]. This fact causes variation of results reached by classic methods using a signal with constant amplitude and the exponential signal test method. Applications of a frequency-swept signal suitable for economic tests for ADC testing are described in [4].

The band signal is used to save the testing time. A test using an AM signal produces the average performance of the Devices Under Test (DUT) i.e. *SINAD* and *ENOB*. It means that 3 different tones are used for testing at the same time. The time-saving benefit is achieved using every band signal. However, AM and FM signals are frequently used in communications and they can be used for DAC testing too. It is possible to use a similar approach as one used for testing of the ADCs. The DACs are widely used in signal generators, thus it is very important to test them using inartificial signals. Still it cannot be

clear why just modulated signals are used, a similar spectrum has generally a multi-tone signal, which is composed of sum of chosen sine-waves. In this case the answer is very simple: only 4 are needed to describe the modulated signal (amplitude, carrier frequency, modulation frequency, modulation index). It is significant when the number of tones is increasing. A FM signal which is composed of 33 spectral components is still defined by 4 parameters; a general multi-tone signal is defined by 33 amplitudes, 33 frequencies and optionally 33 phase shifts.

This paper shows only AM and FM signals for ADC or DAC testing, however the original idea is to test a general DUT by the signal which results from natural application of each DUT or it is similar to application. In radio engineering a DUT is for example a generator with chosen modulation and a receiver. The result from this test is the Bit Error Rate Ratio BERR, in this case it is a mixed signal test. The testing signal in this case is the chosen modulated signal. In this paper the DUT is not a transmitter, a channel with noise and a receiver, but the DAC and its performance is measured using *SINAD* and *ENOB*. Not every type of signal is suitable for DAC testing. It has to impeach limitation of DACs like bandwidth or slew rate etc. (digital modulation like QAM represents this type, which is not suitable for DAC testing)

2. FFT tests

The performance of the DUT is evaluated in the frequency domain in a FFT test. The data $u_0, u_1 \dots u_{M-1}$ are sent to the input of the DAC, generated, measured by an ADC and transformed by the DFT (FFT) algorithm.

In case of coherent sampling the following condition is valid: $K \times f_{\text{SIGNAL}} = m \times f_{\text{SAMPLING}}$, where K and m are integers. If this condition cannot be satisfied it is necessary to apply a window.

2.1 Standard sine wave FFT test of AD converters

Signal Noise and Distortion SINAD is the ratio of the *RMS* value of the carrier frequency to the mean value of the root-sum-square of all other spectral components, including harmonics, but excluding the DC component [1, 2, 3].

$$SINAD = 20 \log \frac{Signal_{RMS}}{NAD_{RMS}}, \quad (1)$$

where n is the number of nominal bits of the converter under test.

For a single-tone signal, *SINAD* and *ENOB* are given by the following equation [7],

$$SINAD = 6.02ENOB + 1.76 \text{ (dB)}. \quad (2)$$

When the coherent sampling condition is not satisfied, it is necessary to apply the procedure of input signal windowing. Every operation, including windowing, which changes the shape of the signal, changes also the *CF*. Then another formula for an *ENOB* computation has to be applied (6). This phenomenon is stated in [8], its principle will be briefly shown. For estimating *ENOB*, it is necessary to compensate the *CF* influence. There is the known formula for *SNR*:

$$SNR = 10 \log \frac{\sigma_x^2}{\sigma_n^2} = 10 \log \frac{12\sigma_x^2}{2^{-2n} X_{PP}^2} \text{ (dB)}; \quad (3)$$

$$SNR = 10.8 + 6.02n - 20 \log \frac{X_{PP}}{\sigma_n} = 4.77 + 6.02 - 20 \log CF \text{ (dB)}, \quad (4)$$

where σ_n is standard deviation of noise, σ_x is standard deviation of the input signal, X_{pp} is the peak-to-peak value of the input signal, n is the nominal number of bits and $CF = X_{pp} / (2\sigma_x)$. For a sine wave signal or FM signal, the amplitude $X_m = X_{pp}/2 = FS/2$, the $\sigma_x = X_{pp} / 2 / \sqrt{2}$, then n is given by the next equation [8],

$$n = \frac{SNR - 1.76}{6.02} \quad (\text{bit}). \quad (5)$$

It is possible to express the general formula for $ENOB$ using the CF correction [9]:

$$ENOB_{\text{cor}} = \frac{SINAD - 4.77 + 20 \log CF}{6.02} \quad (\text{bit}). \quad (6)$$

For the $SINAD$ correction the formula (2) is used, only $ENOB$ is replaced by $ENOB_{\text{cor}}$. This approach is equivalent to the correction of window influence [10].

2.2 Amplitude modulation FFT test

The amplitude modulated signal is defined by formula [11]

$$\begin{aligned} u_{\text{AM}} &= (U_c + U_m \cos \omega_m t) \sin \omega_c t = \\ &= U_c \sin \omega_c t + \frac{U_m}{2} [\sin(\omega_c - \omega_m) \cdot t + \sin(\omega_c + \omega_m) \cdot t]. \end{aligned} \quad (7)$$

The *modulation depth* $m_{\text{AM}} = U_m / U_c$ affects the character of the frequency spectrum of the signal. We consider Dual Side Band amplitude modulation with $m_{\text{AM}} \leq 1$. Its spectrum contains a carrier with frequency ω_c , amplitude U_c and two sideband components with frequencies $\omega_c \pm \omega_m$ and amplitude $U_m/2$. In the special case when $U_c = 0$, the carrier frequency is eliminated, but the sidebands remain. That is double-sideband suppressed-carrier transmission. In fact, we can use it as *Dual Tone Test* with symmetrically distributed spectral components and signal processing is the same as in the classic Dual Tone methods. It is possible to fit the AM signal by the *Multi-tone Fit Test (least square fit method)*, which optimizes 3 amplitudes, 3 frequencies, 3 phase shifts and 1 offset. The easier way to obtain results is to apply spectral analysis of an AM signal. We can define $SINAD_{\text{AM}}$ similarly as in a classic FFT test without CF correction [9]:

$$SINAD_{\text{AM}} = \sqrt{\frac{\frac{U_c^2}{2} + \frac{U_m^2}{4}}{\sum_{f \neq 0, f_c, f_m} \frac{U_f^2}{2} - \frac{U_c^2}{2} - \frac{U_m^2}{4}}}, \quad (8)$$

where U_c a U_m are amplitudes of the carrier and the modulation, U_f represents amplitudes of other spectral components.

Input voltage in the time domain should be equal to full-scale of the ADC, i.e. it is necessary to satisfy the following condition:

$$U_{\text{FS}} = U_c + U_m. \quad (9)$$

The CF of an AM signal can be expressed by:

$$CF_{AM} = \frac{2(1 + m_{AM})}{\sqrt{2 + m_{AM}^2}}. \quad (10)$$

The *ENOB* is computed from *SINAD* (6); the corrected *SINAD* has to be again recomputed by formula (2).

Another approach is to compute *SINAD* and *ENOB* using standard formulas and then apply a correction $\Delta SINAD$ (11) and $\Delta ENOB$ (12):

$$\Delta SINAD_{AM} = 20 \log \left(CF_{AM} / \sqrt{2} \right) \text{ (dB)}; \quad (11)$$

$$\Delta ENOB_{AM} = \frac{\Delta SINAD_{AM}}{6.02}. \quad (12)$$

Table 1. *SINAD* and *CF* reduction in case of using an AM signal

m_{AM} (-)	<i>CF</i> (-)	$\Delta SINAD$ (dB)	$\Delta ENOB$ (bits)
0.25	1.74	-1.8	-0.3
0.50	2.00	-3.0	-0.5
1.00	2.31	-4.3	-0.7

2.3 Frequency modulation FFT test

The FM modulated testing signal is defined as $u_{FM} = U_c \sin[\omega_c(t) \cdot t]$, modulation frequency $\omega_c(t) = \omega_{c0} + \Delta\omega \cos(\omega_m t)$, where $\Delta\omega$ is the frequency deviation of the modulated signal, $m_{FM} = \Delta\omega/\omega_m$ is the modulation index. The waveform of the frequency modulated signal is [12] :

$$u_{FM} = U_c \sin \left(\omega_c t + \frac{\Delta\omega}{\omega_m} \cos \omega_m t \right). \quad (13)$$

Spectrum of the FM consists of a carrier with frequency ω_c and symmetrically displaced spectral components around the carrier ω_c with multiples of frequency ω_m . Amplitudes of spectral components are given by first order Bessel functions with argument $\Delta\omega/\omega_m$. In Tab. 2, the amplitudes of spectrum of the frequency modulated signal are shown for a modulation index $m_{FM} = \Delta\omega/\omega_m$ in the range from 0 to 2.

Table 2. FM signal amplitudes of the spectral component

m_{FM}	ω_c	$\omega_c \pm \omega_m$	$\omega_c \pm 2\omega_m$	$\omega_c \pm 3\omega_m$
0	1.00			
0.25	0.98	0.12		
0.50	0.94	0.24	0.03	
1.00	0.77	0.44	0.11	0.02
1.50	0.51	0.56	0.23	0.06
2.00	0.22	0.58	0.35	0.13

Fitting this signal is similar to the previous case, it is possible to use the *Least Square* method (Multi Tone Fit Test), but it is very difficult to optimize too many parameters. It is convenient to evaluate a signal in the spectral domain and determine the *Signal Noise and Distortion SINAD_{FM}*, [9]

$$SINAD_{FM} = \sqrt{\frac{U_c^2 + \sum_{k=1,2,\dots} U_{km}^2}{\sum_{f \neq 0, f_c, k \cdot f_m} U_f^2 - U_c^2 - \sum_{k=1,2,\dots} U_{km}^2}}, \quad (14)$$

where U_c is the *RMS* value of the carrier component, U_{km} corresponds to the *RMS* value of signal components around the carrier frequency, U_f are *RMS* values of other spectral components. The peak-to-peak value of an input voltage in the time domain has to cover the full scale of the ADC ($U_{FS} = U_c$), see (13).

The FM signal has the same *CF* as a sine wave signal, therefore equation (2) can be used for *ENOB* calculation.

3. Test setup and results

An application of modulated signals for DAC has to satisfy the following criteria: The DAC should be tested near its full scale range. The amplitude of the signal should respect this fact. The modulation index of the AM signal affects the amplitude of side-band spectral components. In this work the modulation index is chosen as $0.25 \div 1$. A lower modulation index causes that the averaged *ENOB* is reassembling to the single tone test. The FM modulation index is essential for DAC testing, because it affects the signal bandwidth. The carrier frequency sets the central frequency of the signal in the spectral domain and the modulation frequency sets the spacing between spectral components.

For practical verification of the AM and FM methods, a PXI system was used. The first output channel of the DAQ NI PXI 6251 (2 analog outputs: 16-bit, 1.25 MSa/s or 1 analog output: 16-bit 1.8MSa/s, 16 analog inputs: 16-bit ADC, 1.25 MSa/s) was tested. The Digitizer (NI PXI 5922 24 bit, 500 kSa/s, or 16 bits, 15 MSa/s) was chosen as a reference device. The modulation method was compared with a sine wave DFT test. For all measurements the Hanning window was used. 1 MSa were acquired during measurement.

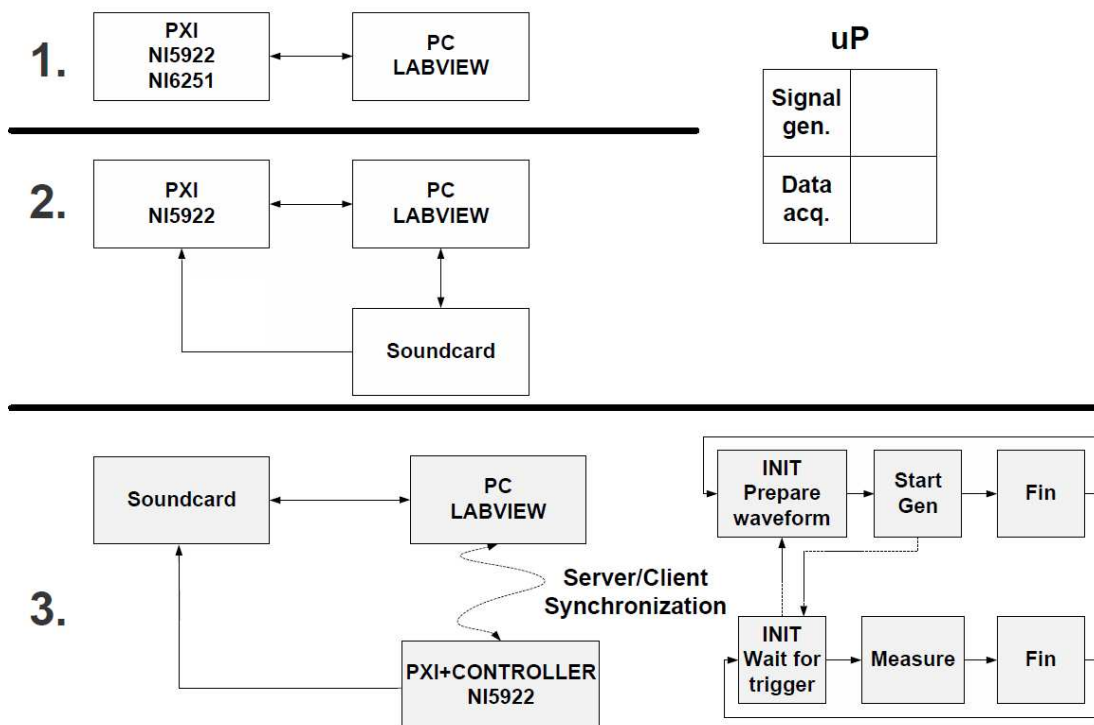

Fig. 1 Three arrangements of the testing system

The whole PXI testing system was programmed in LabView. For purpose of testing, 3 modifications of virtual instrument were developed, as shown in Fig. 1

The first two virtual instruments use one PC to control generating data and data acquisition. The generating part runs in one core of the processor and data acquisition runs in the second core.

The third arrangement is suitable for those cases where the performance of the PC is not sufficient. A distributed measuring system was developed. The generating part runs in a PC and control soundcard. The data acquisition part runs in a PXI with controller. Synchronization is made via the TCP protocol.

3.1 Results of DAC testing using a sine wave DFT test

Firstly the DUT was tested by a single tone test. It was tested using four different frequencies (3357.8 Hz, 7359.87 Hz, 9784.52 Hz and 15987.41 Hz), see Fig. 2 and Fig. 3.

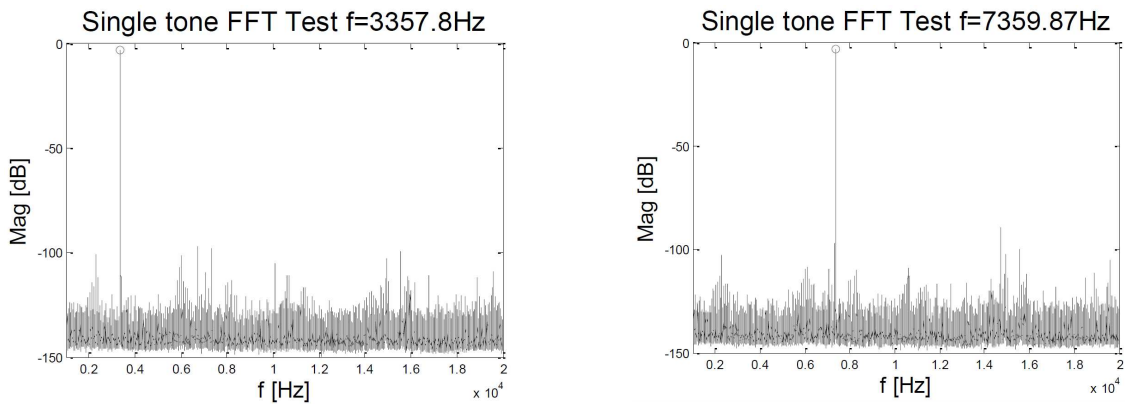

Fig. 2 Spectrum of sine wave signal $f_1 = 3.3578$ kHz (left) $f_2 = 7.3599$ kHz (right)

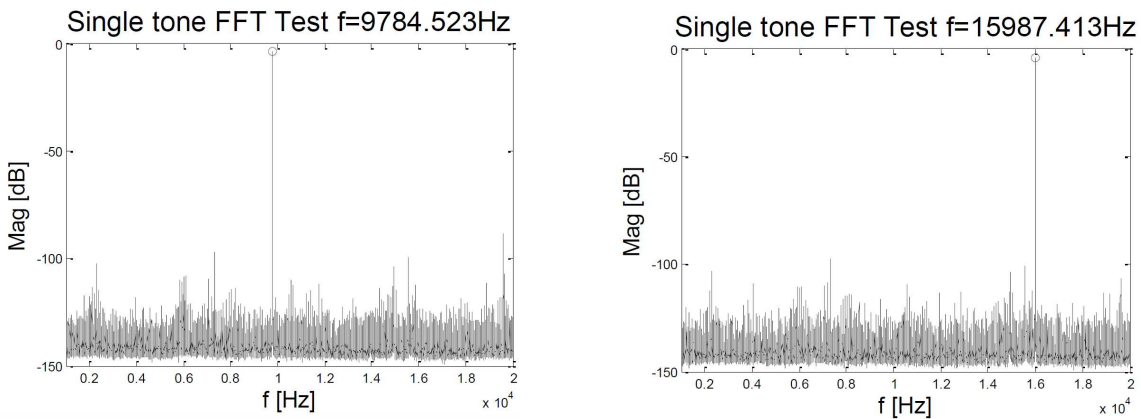

Fig. 3 Spectrum of sine wave signal $f_3 = 9.785$ kHz (left) $f_4 = 15.987$ kHz (right)

Table 3. Sine wave DFT test results

f (Hz)	CF (-)	CF_w (-)	$SINAD$ (dB)	$ENOB$ (bits)	$SINAD_{cor}$ (dB)	$ENOB_{cor}$ (bits)
3357.8	1.41	2.31	83.6	13.6	87.9	14.3
7359.8	1.41	2.31	82.2	13.4	86.5	14.1
9784.5	1.41	2.31	81.2	13.2	85.5	13.9
15987.4	1.41	2.31	84.2	13.7	88.5	14.4

Results are shown in Tab. 3. For incoherent sampling the Hanning window was applied. It is necessary to correct the influence of the Hanning window. The original sine wave has $CF = \sqrt{2}$. CF_w respecting the fact that the window changes the shape of the signal.

3.2 Results of DAC testing using an AM DFT test

Secondly the DUT was tested by an AM DFT test. Two different carrier frequencies f_c (7.785 kHz and 12.385 kHz) were used for testing, while the modulation frequency f_m is still the same (3.36 kHz). The modulation index was chosen as 0.25, 0.5 and 1, see Fig. 4 – 6.

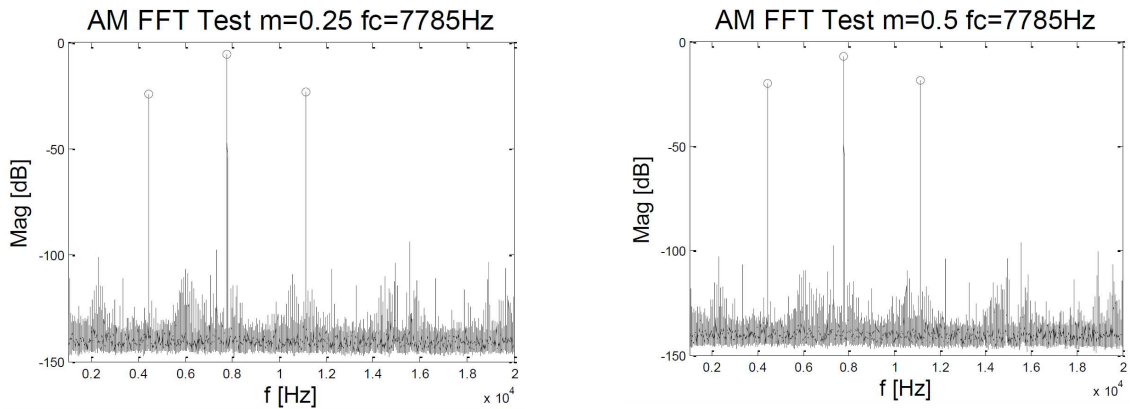

Fig. 4 Spectrum of AM signal $f_c=7.785$ kHz, $f_m=3.36$ kHz, $m_{AM}=0.25$ (left), $m_{AM}=0.5$ (right)

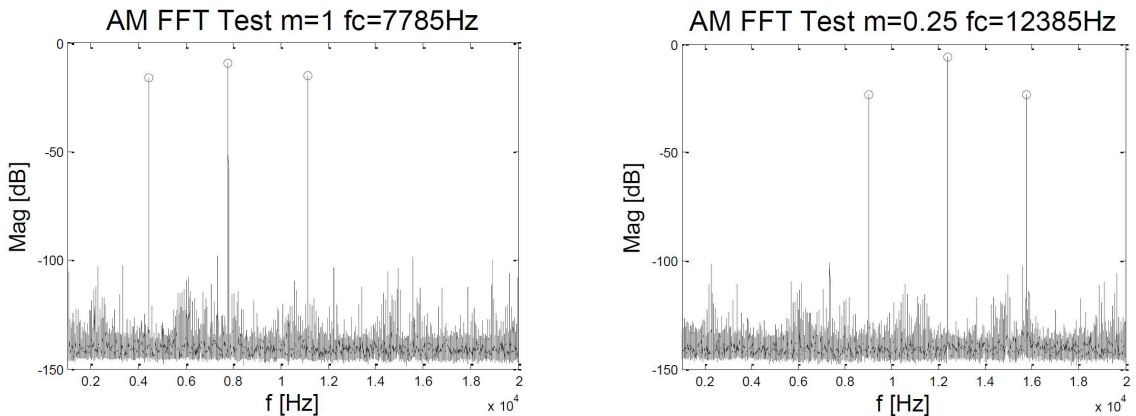

Fig. 5 Spectrum of AM signal $f_c=7.785$ kHz, $f_m=3.36$ kHz, $m_{AM}=1$ (left), $f_c=12.385$ kHz, $f_m=3.36$ kHz, $m_{AM}=0.25$ (right)

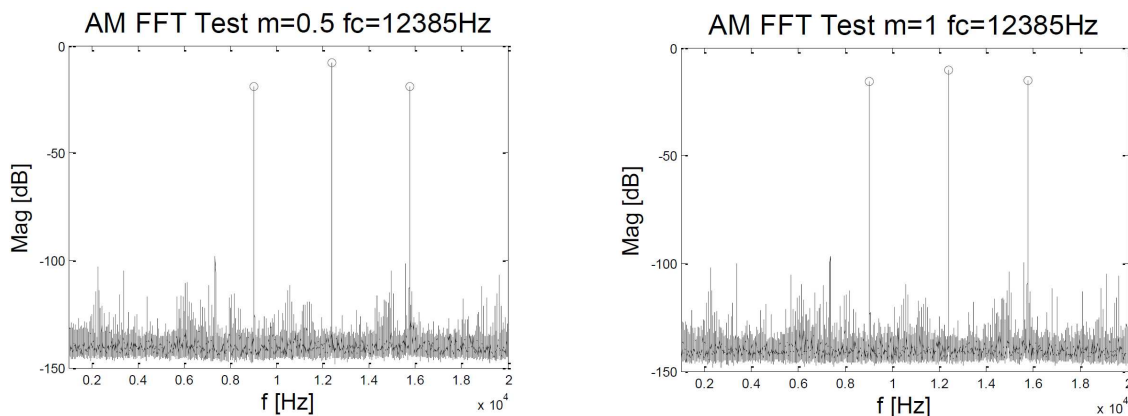

Fig. 6 Spectrum of AM signal $f_c=12.385$ kHz, $f_m=3.36$ kHz, $m_{AM}=0.5$ (left), $m_{AM}=1$ (right)

Results are shown in Tab. 4. In this case not only the window but also the modulation index affects the CF .

Table 4. AM DFT test results

$f_m=3.36$ kHz							
m_{AM} (-)	f_n (kHz)	CF (-)	CF_w (-)	$SINAD$ (dB)	$ENOB$ (bits)	$SINAD_{cor}$ (dB)	$ENOB_{cor}$ (bits)
0.25	7.79	1.74	2.84	81.2	13.2	87.2	14.2
0.50	7.79	2.00	3.26	80.1	13.0	87.4	14.2
1.00	7.79	2.31	3.77	79.0	12.8	87.5	14.3
0.25	12.39	1.74	2.84	82.7	13.4	88.7	14.4
0.50	12.39	2.00	3.26	81.3	13.2	88.6	14.4
1.00	12.39	2.31	3.77	79.8	13.0	88.3	14.4

3.3 Results of DAC testing using a FM DFT test

Thirdly the DUT was tested by a FM signal. Parameters of the signal were the following: carrier frequency $f_c = 9785$ Hz, modulation frequency $f_m = 531.58$ Hz. The modulation index was chosen as 0.25, 0.5, 1, 2, 4 and 8, see Fig. 7 - 9.

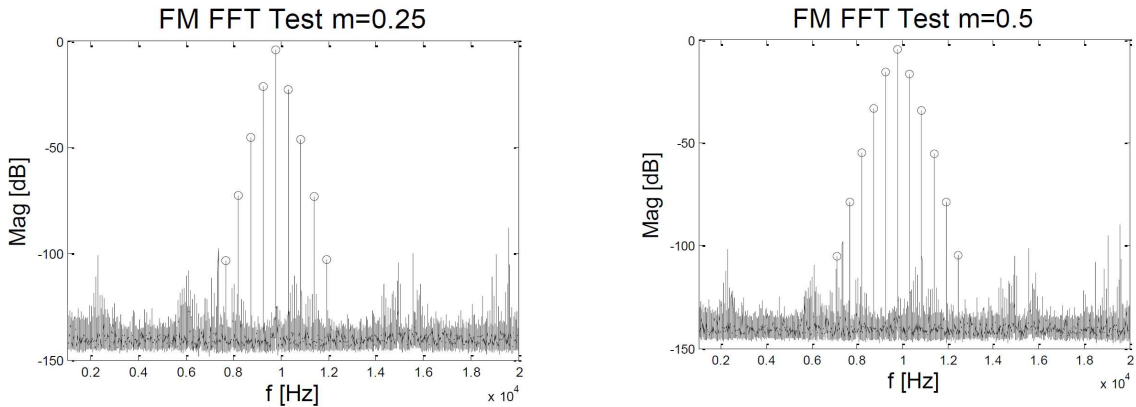

Fig. 7 Spectrum of FM signal $f_c=9.785$ kHz, $f_m=531.58$ Hz, $m_{FM}=0.25$ (left), $m_{FM}=0.5$ (right)

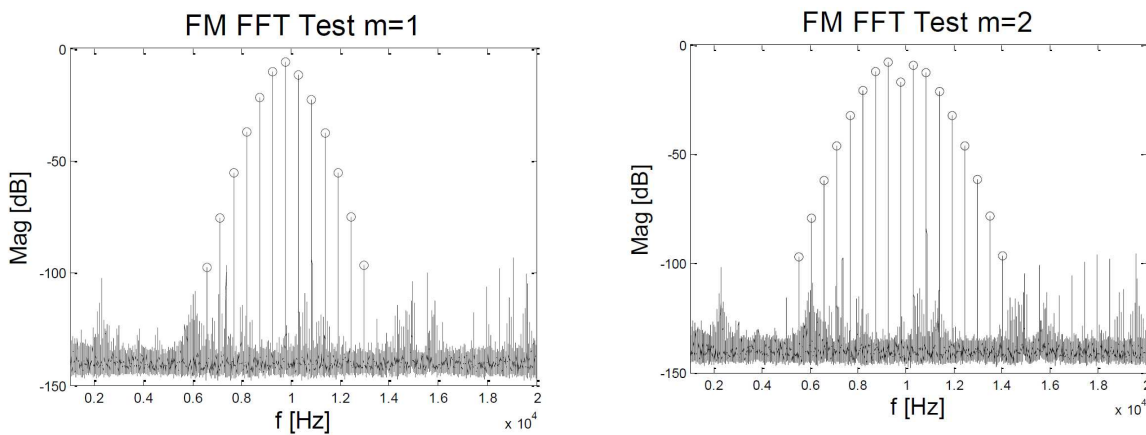

Fig. 8 Spectrum of FM signal $f_c = 9.785$ kHz, $f_m = 531.58$ Hz, $m_{FM} = 1$ (left), $m_{FM} = 2$ (right)

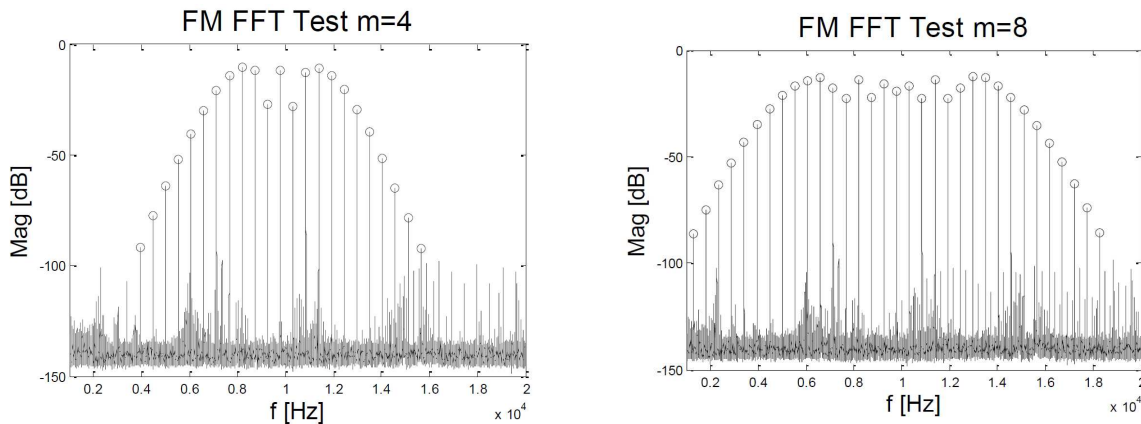

Fig. 9 Spectrum of FM signal $f_c=9.785$ kHz, $f_m=531.58$ Hz, $m_{FM}=4$ (left), $m_{FM}=8$ (right)

Results from the FM FFT Test are shown in Tab. 5. It is interesting that m_{FM} changes do not affect the CF .

Table 5. FM DFT test results

$f_n=9785$ Hz, $f_m=531.58$ Hz						
m_{FM} (-)	CF (-)	CF_w (-)	$SINAD$ (dB)	$ENOB$ (bits)	$SINAD_{cor}$ (dB)	$ENOB_{cor}$ (bits)
0.25	1.41	2.31	81.4	13.2	85.7	13.9
0.50	1.41	2.31	81.9	13.3	86.1	14.0
1.00	1.41	2.31	82.6	13.4	86.9	14.1
2.00	1.41	2.31	82.6	13.4	86.8	14.1
4.00	1.41	2.31	82.9	13.5	87.1	14.2
8.00	1.41	2.31	82.8	13.5	87.1	14.2

4. Summary

In Tab. 6. AM, FM methods with sine wave FFT test are compared. The comparison is made in such a way that the results from the test using a modulated signal with certain carrier frequency are compared with sine wave FFT test results using a similar signal frequency. For example a FM FFT test with 9.8 kHz carrier frequency is compared with a 9.8 kHz sine wave FFT test. The biggest value of the difference between the reference method and non-traditional method is equal to 0.3 bits. The reason why AM and FM methods show better results than a single-tone method, is that more signal spectral components cover a broader frequency band and potentially can mask distortion.

Table 6. Results of comparison between AM, FM methods and sine wave method

Sine wave		AM				FM, $f_n = 9785$ Hz		
f (kHz)	$ENOB$ (bits)	m_{FM} (-)	$ENOB_{cor}$ (bits)	$\Delta ENOB_{cor}$ (bits)	m_{AM} (-)	f_n (kHz)	$ENOB_{cor}$ (bits)	$\Delta ENOB_{cor}$ (bits)
3.35780	14.3	0.25	7.8	14.2	-0.1	0.25	13.9	0.0
7.3598	14.1	0.50	7.8	14.2	-0.2	0.50	14.0	-0.1
9.7845	13.9	1.00	7.79	14.2	-0.2	1.00	14.1	-0.2
15.9874	14.4	0.25	12.4	14.4	0.0	2.00	14.1	-0.2
		0.50	12.4	14.4	0.0	4.00	14.2	-0.3
		1.00	12.4	14.4	0.0	8.00	14.2	-0.3

The aim of this article is to verify possibilities of DAC testing using multi-harmonic signals such as AM and FM signals. Signal processing of these signals in the time domain using fitting methods is quite complicated. An advantage of those methods is ascertaining DAC parameters in a wider frequency range without the need of measuring their frequency characteristic. Therefore it can be expected that the described methods will find application in industry for less-demanding and economical tests.

Another goal of this paper is to find a suitable testing signal which covers an evenly chosen bandwidth of the DUT and this signal is not completely artificial. This method is suitable for testing arbitrary generators (Agilent 33120A can generate an FM signal with f_c from 10 mHz to 10 kHz and deviation from 15 mHz to 15 MHz). However this paper does not show results suitable for i.e. audio applications (the carrier frequency of the signal is much higher than the band of the modulated signal).

For example, if one cycle of data collection takes 2 seconds and 20 cycles are necessary for an averaged FFT, then measurement at 1 frequency lasts 40 seconds. If we want to test carefully the performance of the DAC in a range of 20 kHz in 33 steps, the test will take 1320 seconds. If we use an FM signal with $m = 8$, the duration of the test will be only 40 seconds. However the $ENOB$ measured using an FM signal, represents the average performance of the tested DAC.

It is possible to shorten the test duration by reducing the number of samples. Tab. 7 shows how the number of samples affects the results of the test; a single tone test and a test using a FM signal with $m = 1$ was arranged for comparison. The single-tone FFT method is robust and works fine even if the number of samples is very limited (RMS of the signal and noise does not change significantly). A FM test for chosen parameters works properly, if up to 250 kSamples are acquired, otherwise the spectral lines are too close. This paper does not show results suitable for i.e. audio application (the carrier frequency of the signal is much higher than the band of the modulated signal), which needs special sampling methods.

Table 7. Results of comparison between AM, FM methods and the sine wave method

	Single-Tone	FM signal
Samples (MSa)	$ENOB_{cor}$ (bit)	$ENOB_{cor}$ (bit)
2.000	14.3	14.2
1.000	14.3	14.2
0.500	14.2	14.2
0.250	14.3	14.2
0.125	14.4	-
0.060	14.3	-
0.030	14.3	-

5. Acknowledgment

This project is supported by the research program No. MSM6840770015 "Research of Methods and Systems for Measurement of Physical Quantities and Measured Data Processing" of the CTU in Prague sponsored by the Ministry of Education, Youth and Sports of the Czech Republic and the grant SGS10/207/OHK3/2T/13 "Digitization, synchronization and signal processing in sensors and sensor networks".

6. References

- [1] DYNAD (2000). Methods and draft standards for the Dynamic characterization and Testing of Analogue to Digital Converters. <http://paginas.fe.up.pt/~hsm/dynad/>.
- [2] IEEE Standard 1241-2000. (2000). IEEE Standard and Terminology and Test Methods for Analog-to-Digital Converters. New York.
- [3] IEEE P1658 TM/D03.6. (1988). Draft Standard for Terminology and Test Methods for Digital-to-Analog Converters. New York.
- [4] Vedral, J., Fexa, P., Svatoš, J. (2009). Methods for economical test of dynamic parameters ADCs. *Metrology and Measurement Systems*, 15(1), 161-170.
- [5] Vedral, J. (2008). Exponential Fit Test - Theoretical Analysis and Practically Implementation *13th Workshop on ADC Modelling and Testing* [CD-ROM]. University of Florence Florence, 1033-1036.
- [6] Holcer, R., Michaeli, L. (2003). DNL ADC Testing by the exponential shaped voltage. *IEEE Transaction on Instrumentation and Measurement*, 52 (3), 946-949.
- [7] App. Note 641. (2002). ADC and DAC Glossary. *Sunnyvale: Maxim Integrated Products*, 22.
- [8] Oppenheim, A., Schafer, R. (1989). *Discrete-Time Signal Processing*. Prentice-Hall.
- [9] Vedral, J. (2010). ADC testing with poly-harmonic signals. *Mixed-Signals, Sensors and Systems Test Workshop (IMS3TW)*. IEEE 16th International. IEEE, 1-4.
- [10] Dallet, D., Silva, J. (2005). *Dynamic characterisation of analogue-to-digital converters*. Springer Verlag.
- [11] Newkirk, D, Karlquist, R. (2004). Mixers, modulators and demodulators. *The ARRL Handbook for Radio Communications* (81st ed.). Newington: ARRL, 15.1–15.36.
- [12] Boashash, B. (2003). *Time-Frequency Signal Analysis and Processing – A Comprehensive Reference*. Elsevier Science. Oxford.